



# Welkom in onze wereld van warmte







# ATAG Energion M Plus

## Buffervat parallel

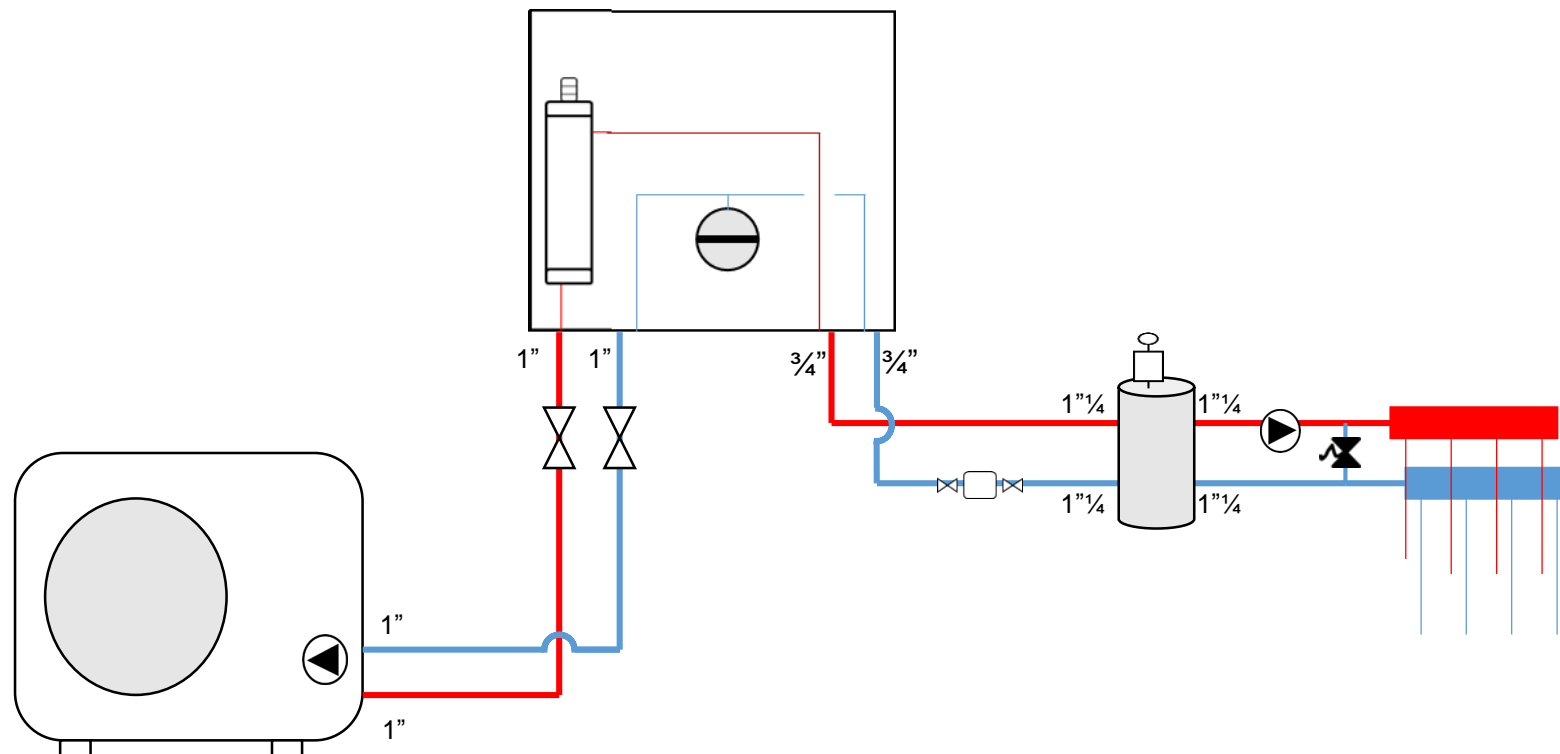
# ATAG Energion M 4-5-7T kW Plus Buffervat parallel

ATAG Energion M Systemen	Artikelnummers
<b>1-fase</b>	
Energion M Plus 4	3069700
Energion M plus 5	3069702
<b>3-fase</b>	
Energion M Plus 7T	3069708
<b>Regelingen</b>	
ATAG CUBE	AACUBE0U
ATAG One Zone zwart	AAONEZ0Z
ATAG One Zone wit	AAONEW0Z
<b>Overige Accessoires</b>	
Energion Boiler 180	3060451
Verwarmingselement, 180 ltr boiler	3024396
Tapwaterset 4-5-7 kW	3318903
Leidingset flexibel 1 mtr	3078151
Leidingset flexibel 3 mtr	3078152
Leidingset flexibel 10 mtr	3078153
Anti bevroingsset	3318771
Steunbalken, rubber, met geleiderails	3078097
Verwarmingselement condensafvoer	3319087
Condensverzamelbak	3024383
Muurbeugel buiten unit	3078101
trillingsdemper ( 4x) t.b.v. muurbeugel	3078102
Cv-buffervat 50 liter	3060713



-  = Magneetvuil filter
-  = Automatische ontluchter
-   = Afsluitkraan

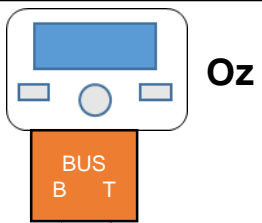

# Binnen unit ATAG Energion M 4-5-7T kW Plus Buffervat parallel

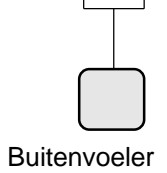

Bus is polariteit gevoelig  
B op B T op T



Externe pomp

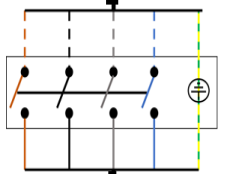
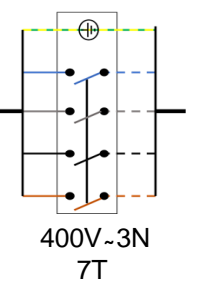
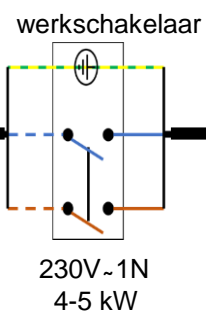
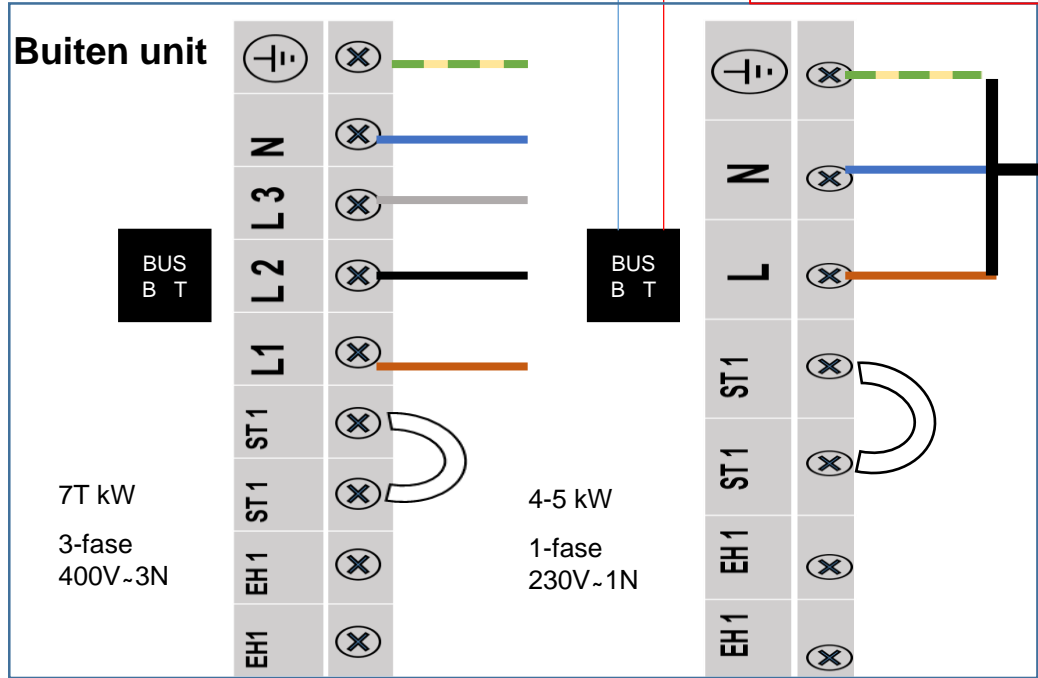



werkschakelaar  
400V~3N

# ATAG Energion M 9T-11T kW Plus Buffervat parallel

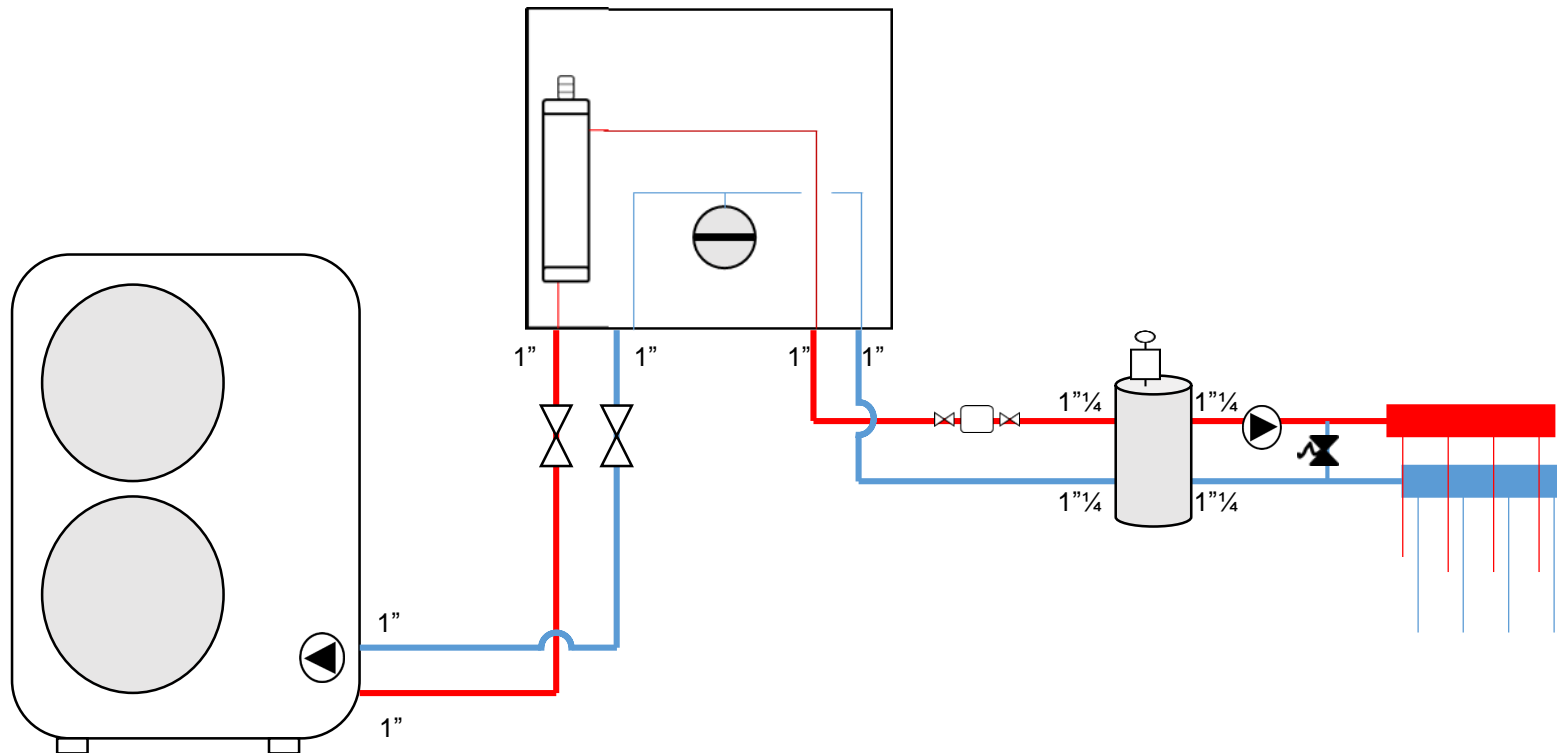
ATAG Energion M Systemen	Artikelnummers
<b>3-fase</b>	
Energion M Plus 9T	3069710
Energion M Plus 11T	3069711
<b>Regelingen</b>	
ATAG CUBE	AACUBE0U
ATAG One Zone zwart	AAONEZ0Z
ATAG One Zone wit	AAONEW0Z
<b>Overige Accessoires</b>	
Energion Boiler 180	3060451
Verwarmingselement, 180ltr boiler	3024396
Tapwaterset 9T-11T kW	3318904
Leidingset flexibel 1 mtr	3078151
Leidingset flexibel 3 mtr	3078152
Leidingset flexibel 10 mtr	3078153
Anti bevrozingset	3318771
Steunbalken, rubber, met geleiderails	3078097
Verwarmingselement condensafvoer	3319087
Condensverzamelbak	3024383
Muurbeugel buiten unit	3078101
trillingsdemper ( 4x) t.b.v. muurbeugel	3078102
Cv-buffervat 50 liter	3060713



-  = Magneetvuil filter
-  = Automatische ontluchter
-  = Afsluitkraan



Oz

ATAG Energion M 9-11T kW

Buffervat parallel

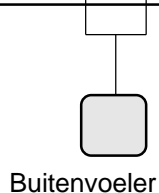

One zone



B T

Bus is polariteit gevoelig  
B op B T op T

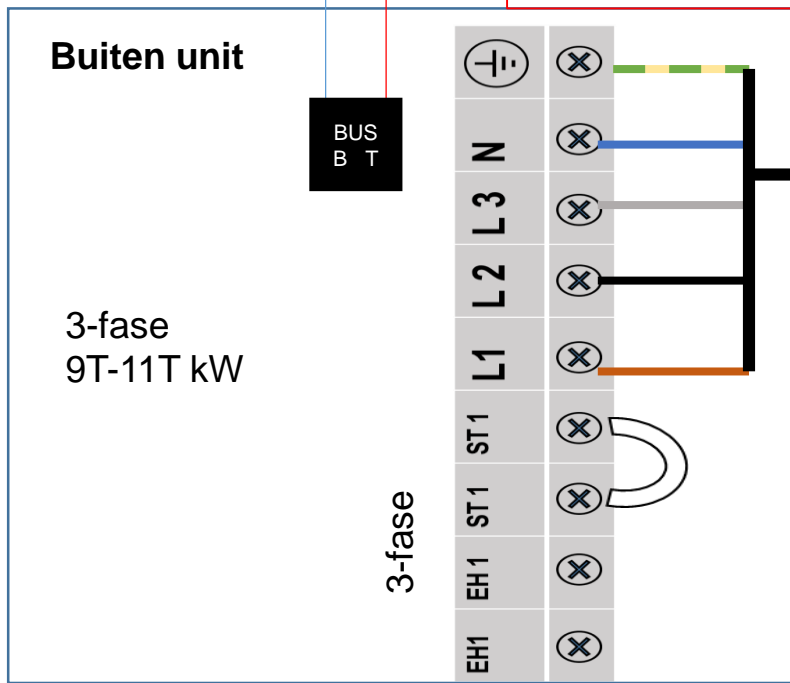

werkschakelaar

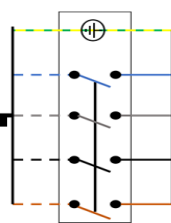

400V~3N

Externe pomp

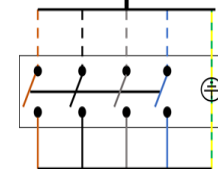

werkschakelaar  
400V~3N

